

- #14 Bare Copper Wire Input Connections
- BNC (Amphenol) Output Connector

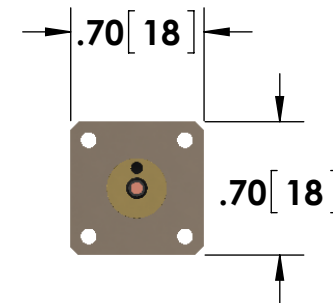
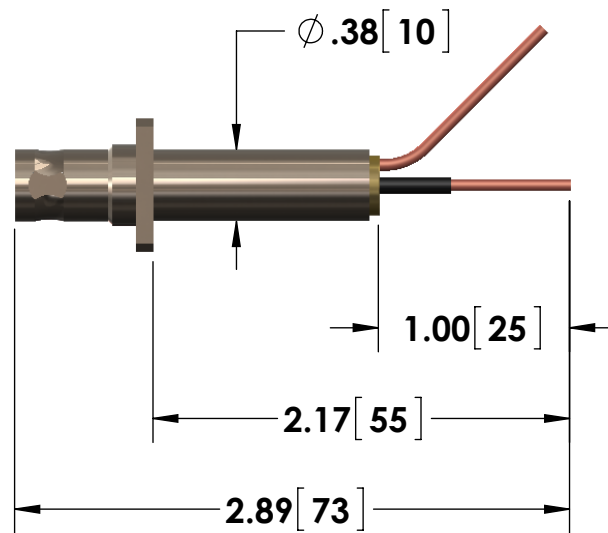

Specifications subject to change without notice.

**Powertek**

TITLE: SDN SERIES - 2 WATT UNIT

DIMENSIONS: inch[mm]

DATE: 03-13-2015